

How to Create Affordable, Modular, Light-Weight, Underactuated, Compliant Robot Hands

Agisilaos G. Zisimatos, Minas V. Liarokapis, Christoforos I. Mavrogiannis,
George P. Kontoudis and Kostas J. Kyriakopoulos



Technical Report, Control Systems Lab
School of Mechanical Engineering, National Technical University of Athens

Athens, January 2015



OpenBionics by www.openbionics.org is licensed under a Creative Commons Attribution-NonCommercial-ShareAlike 4.0 International License.

OPENBIONICS

Contact:

Agisilaos G. Zisimatos, George P. Kontoudis and Kostas J. Kyriakopoulos are with the Control Systems Lab, School of Mechanical Engineering, National Technical University of Athens, 9 Heroon Polytechniou Str, Athens, 15780, Greece (email:{el08087,mc11681,kkyria}@mail.ntua.gr).

Minas V. Liarokapis is with the Dept. of Mechanical Engineering and Materials Science, School of Engineering and Applied Science, Yale University, 9 Hillhouse Avenue, New Haven, CT, 06520, USA (email:minas.liarokapis@yale.edu).

Christoforos I. Mavrogiannis is with the Sibley School of Mechanical & Aerospace Engineering, Cornell University, Ithaca, NY, 14853, USA (email:cm694@cornell.edu).

For any inquiry and/or suggestion you may contact: Agisilaos Zisimatos (email:el08087@mail.ntua.gr), Minas Liarokapis (email:minas.liarokapis@yale.edu).

Contents

1	Introduction	3
2	Design	4
	2.1 Robot Finger Structure	4
	2.2 A Robot Hand Basis that Provides Modularity	5
	2.3 A Disk Shaped Differential Mechanism	5
3	Robot Hand Specifications	6
	3.1 Robot Hand Physical Characteristics	6
	3.2 Design Parameters	6
	3.3 Finger Workspace	7
	3.4 Force Exertion Capability of Robot Fingers	7
	3.5 Experimental Validation of Robot Hands Efficiency	9
4	Necessary Tools and Materials	10
5	Parts Reference	11
	5.1 Robot Finger	11
	5.2 Robot Hand Base for AX12 Servo	13
	5.3 Robot Hand Base for Standard Servo	15
	5.4 3D Printer Parts	17
	5.5 Before Building	19
6	Robot Finger	20
	6.1 Prepare Parts for the Robot Finger	20
	6.2 Stitching the Rigid Parts onto the Flexure Joints	24
	6.3 Tendon Routing of the Robot Finger	28
	6.4 Install Soft Fingertips	29
	6.5 Install Soft Pad to the Top Plate of the Robot Base	30
	6.6 Install the Robot Fingers to the TopPlate	31
7	Robot Hand Base	34
	7.1 Middle Plate	34
	7.2 Bearing Base	34
	7.3 Bottom Plate with AX12 Servo	35
	7.4 Bottom Plate with Standard Servo	36
	7.5 Robot Base with AX12 Servo	37
	7.6 Robot Base with Standard Servo	38
	7.7 AX12 Servo	39
	7.8 Standard Servo	40
	7.9 Robot Flange for Robot Base with AX12 Servo	41
	7.10 Robot Flange for Robot Base with Standard Servo	42
	7.11 Final Assembly of Robot Hand with AX12 Servo	43
	7.12 Final Assembly of Robot Hand with Standard Servo	44

1 Introduction

In this technical report we present a series of design directions for the development of open-source, affordable robot hands, that are also:

- modular
- light-weight
- intrinsically-compliant
- underactuated

The following sections describe how to construct a series of robot hands with the aforementioned features. For their development we use off-the-shelf materials and equipment that can be easily found in hardware stores. The proposed robot hands, efficiently grasp a series of everyday life objects and are considered to be general purpose, as they can be used for various applications.



Figure 1: Two different versions of the proposed robot hands are depicted.

To name a few, some of the possible applications are: 1) for autonomous grasping and teleoperation/telemanipulation studies, 2) as end-effectors of humanoid robots, 3) for mobile and aerial vehicle platforms that can be modified to be grasping capable, 4) for educational purposes, as they provide a low-cost solution for highly intriguing robotics lessons, 5) or even as affordable myoelectric prostheses that will assist amputees in everyday life tasks, helping them regain part of their lost dexterity. The presented robot hands have been developed through the OpenBionics (www.openbionics.org) initiative [1], which was inspired by the Yale Open Hand Project [2].

2 Design

2.1 Robot Finger Structure

In this section we present the robot finger structure and we explain the design choices made. The proposed design is based on the following simple/bioinspired idea: to structurally reproduce the flexion/extension motions of human fingers, using steady elastomer materials (that introduce also compliance) for a passive extension and cables driven through low-friction tubes for the flexion. These design choices produce a simple mechanism capable to reproduce the agonist/antagonist behavior of human hand, exerting at the same time adequate forces. More details regarding the theoretical foundations and the design choices made can be found in [3].

For the elastomer material, we use appropriate silicone sheets which add adaptability to the structure and provide a more robust and stable behavior even when attempting to grasp objects of complex shapes [4].

The stiffness of the finger joints can be modeled as a stiffness matrix with non-zero values in its diagonal, which allows the robot finger to adapt to objects of different shapes. On the other hand, in manipulation tasks, the uncontrolled out-of-plane motion of the fingers, is typically undesired. In order to balance the two requirements we used a similar tendon routing with Awiwi Hand [5], splitting from one tendon to two as you can see in Fig. 2.

Deformable material is attached at the fingertips. The deformations that arise during contact with the grasped object lead to larger contact areas, resulting in smoother contact force distributions and increased grasp stability, as discussed in [6]. The rigid phalanges and some parts of the finger base were constructed with Plexiglas cut with a laser cutting machine. It should be noted though, that the hereby proposed design can be implemented with any kind of plastic and of course with the desired dimensions. For the assembly of the robot fingers we use fishing line and needles in order to stitch the silicone sheets onto the rigid links (the links have appropriate holes by design).

In order to minimize the friction in the tendon transmission system we use low-friction tubes and a pulley mounted inside the finger base. Therefore the Dyneema fishing line, used as flexor tendon, moves freely within the tendon routing system.

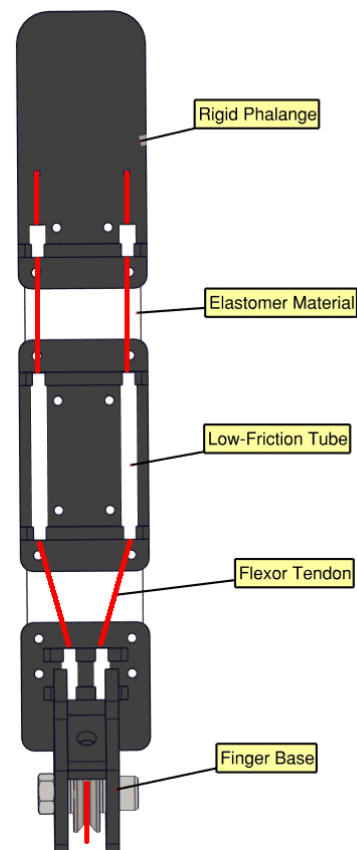

Figure 2: The structure of the robot finger.

2.2 A Robot Hand Basis that Provides Modularity

The proposed basis is equipped with 5 slots and can be used for attaching a total of four fingers, as depicted in Fig. 3. More specifically, robot hands with various geometries of finger base frames can be developed. Those hands are capable of grasping various everyday life objects and each one is specialized for executing different types of grasping tasks. This reflects the basic idea for the presented design, that someone can create multiple, low-cost, task-specific robot hands, instead of one that is complex and expensive.

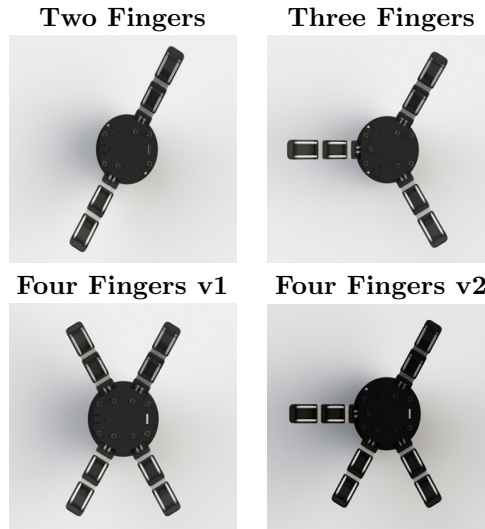

Figure 3: Different robot hands created using identical modular fingers and the robot hand basis. One two-fingered, one three-fingered and two versions of four-fingered robot hands are depicted.

2.3 A Disk Shaped Differential Mechanism

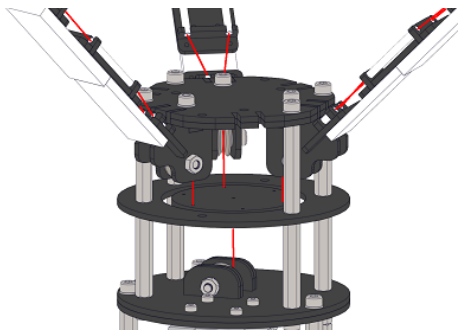

Figure 4: The disk-shaped differential mechanism used in our robot hands.

A disk-shaped differential mechanism has been developed to connect all the independent finger cables with the actuator (servo motor). The differential mechanism allows for independent finger flexions in case that one or multiple fingers have stopped moving, due to workspace constraints or in case that they are already in contact with the object surface. The mechanism is simple since it consists of a few simple parts (a Plexiglas disk, the dyneema fishing line and pulleys) and requires relatively small space in order to perform efficiently. Also, the differential disk moves in the air without being guided by sliders in an effort to minimize friction in the tendon routing system. Our differential mechanism is a variant of the whiffle tree (or seesaw) mechanism [7].

3 Robot Hand Specifications

In this section we present the robot hand specifications, i.e., the physical characteristics (Table 1, finger workspace and forces), design parameters (Table 2) and grasping capabilities. All features refer to a 4-fingered robot hand with the Dynamixel AX12A actuator. All other designs presented, have lower weight but similar characteristics.

3.1 Robot Hand Physical Characteristics

In Table 1, the basic characteristics (dimensions and weight) of a four fingered robot hand version (V1) shown in Fig. 3, are presented.

Table 1: Robot Hand Physical Characteristics

Four Fingered Robot Hand V1	
Actuators	1
Base Height (mm)	110
Base Width (mm)	77
Weight (g)	280

3.2 Design Parameters

Our design is parametrized in the same way, reported in [2]. The parameters are listed in Table 2, to help the creator achieve optimized designs. More details can be found in [8].

Table 2: Robot Hand Design Parameters

Parameter	Default Value
KP, KD (flexure stiffness) (mm)	3, 4
Stiffness Ratio	2.37
KP Length, KD Length (mm)	8, 8
RP, RD (transmission radii) (mm)	2.25, 2.25
Transmission Ratio	1
Finger Length (LP+LD) (mm)	87.3
LP, LD (mm)	44.1, 43.2
Linkage Ratio	0.97
TP, TD (degrees)	14 , 8
LB (mm)	67
Height (mm)	12
Depth (mm)	20
Pad Thickness (mm)	6

Moreover, it should be noted that although in this project we are not proposing anthropomorphic robot hands, we used the metric presented in [9] in order to define the lengths for all phalanges and the relative positions of the finger base frames, maximizing humanlikeness of specific aspects of our design. Such a choice was made based on the hypothesis, that even if we design our simple robot hands as anthropomorphically as possible, we will maximize their ability to grasp objects created for the human hand. For our design we have used identical robot fingers following the dimensions of human index finger and for the distance between the opposing finger base frames we have selected the distance between the CMC of the thumb and the MCP of the index. This distance can be obtained using hand anthropometry studies [10]. More details can be found in [3]. A recent study regarding prosthetic fingers can be found in [11].

3.3 Finger Workspace

The fingers' workspace is presented in Fig 5. The ratio graph between the first and the second angle is depicted in Fig. 6. The joint angles were captured experimentally, using markers at the joints and a vision system.

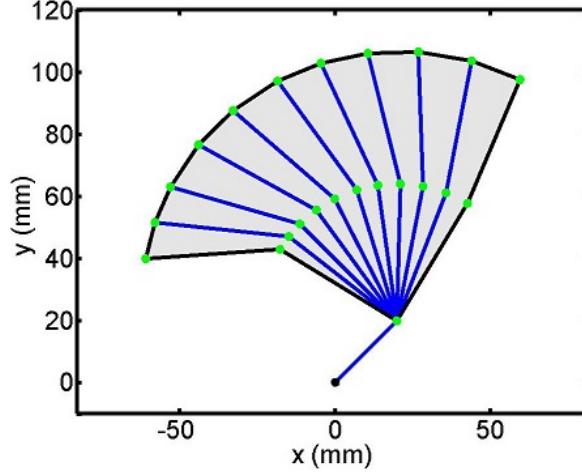

Figure 5: The finger workspace.

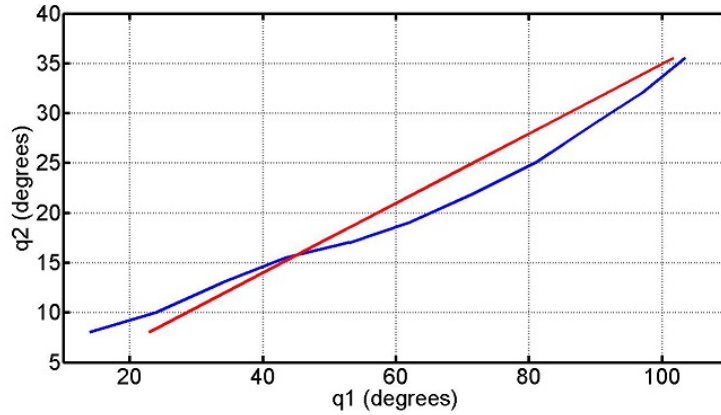

Figure 6: The evolution of the ratio between the two angles. The ratio approximates a constant value of 2.86 (red line).

As we can see in Fig. 5, the proximal phalanx closes faster than the distal phalanx. This was achieved by selecting specific values of stiffness (KP, KD) for the two flexure joints (see Table 2 for details). Such a choice leads to more robust power grasps, as discussed in [4].

3.4 Force Exertion Capability of Robot Fingers

In order to evaluate the force exertion capability of the robot fingers, we measured the maximum force applied by the robot fingertips (distal phalanx) in two different configurations, as depicted in Fig. 7 and Fig. 8. For each configuration, multiple experiments were conducted. The red lines represent the mean values and the blue dotted lines the min and max values per configuration.

The high force values correspond to the 30% flexed case and reach 18N (peak), with a standard low-cost servo. More details can be found in [3].

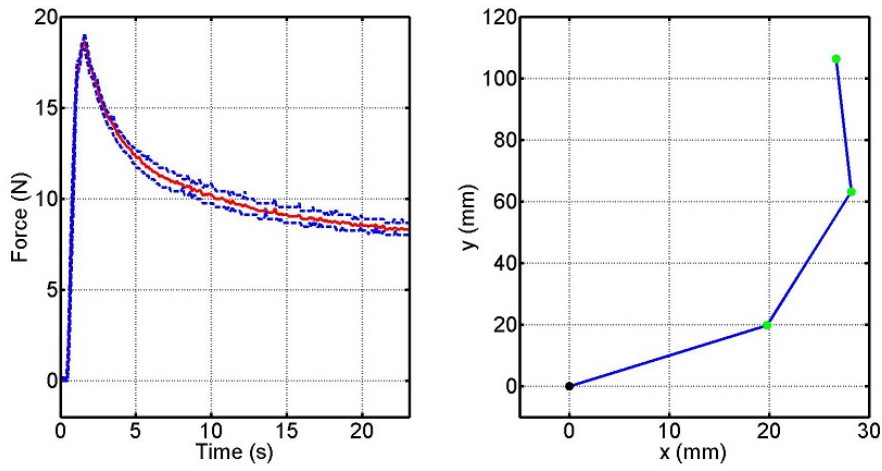

Figure 7: Force exertion for the 30% flexed configuration.

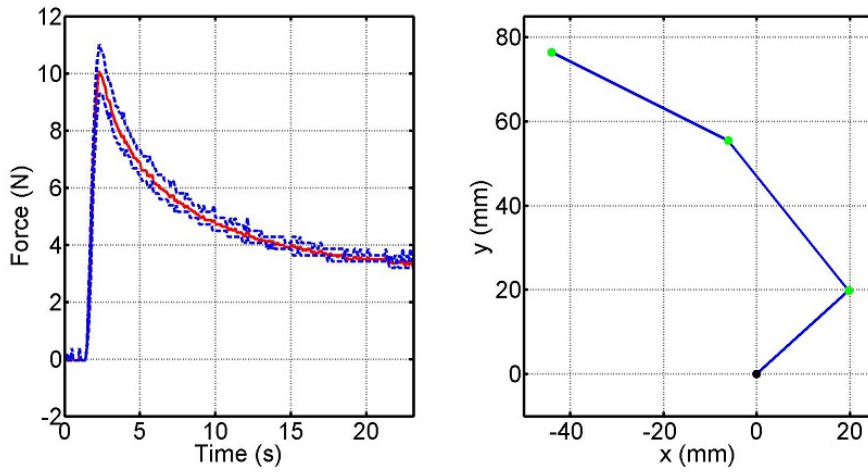

Figure 8: Force exertion for the 70% flexed configuration.

As you can see in Fig. 7 and Fig. 8 the forces drop at the 45% of the maximum force applied and then they remain constant. This phenomenon is caused by the viscoelastic behavior of the silicone sheets [12].

3.5 Experimental Validation of Robot Hands Efficiency



Figure 9: Different robot hand models and robot hands created with the design directions provided, are depicted.

In order to experimentally validate the efficiency of the aforementioned design, we have developed different types of robot hands depicted in Fig. 9 and we have conducted various experiments, with different applications in mind. The videos of the conducted experiments, can be found at the following URLs:

Different applications: <https://www.youtube.com/watch?v=yEANSfaE1gs>
Autonomous grasp planning: <https://www.youtube.com/watch?v=xs2CC9QLuFc>
Greibenstein test: <https://www.youtube.com/watch?v=bniHWeXpX0A>

More details about the experiments and the possible applications, can be found in [3], as well as at the official website of the OpenBionics initiative:

<http://www.openbionics.org>

4 Necessary Tools and Materials

In this section we present the necessary tools and materials for the construction and assembly of the different robot hand parts. All tools and materials used, can be easily found in hardware stores around the world.

Tools



Long Darners [D:1mm, L:70mm]



Precision Ruler



Long-Nose Pliers with Side-Cutting



Cutter



Scissors



Phillips Screwdriver [no. 1,2]



Open-End Wrench [M2, M3 Hex Nut]



Allen Wrench [2.5mm]

Materials



Dyneema Fishing Line [0.4mm]
& Nylon Fishing Line [0.4mm]



Acrylic Glue & Super Glue



Ear Cotton Swabs



Silicone Sheets [3mm, 4mm]



Plexiglas Sheets [2mm, 4mm]



Sponge, Self-Adhesive
& Anti-Slip Tapes

5 Parts Reference

In this section we list all the necessary parts for the assembly of the robot hand. The parts are divided in two categories: i) the robot finger parts and ii) the robot base parts. The second category contains the parts for the AX12 Dynamixel servo base, as well as a second base for a standard RC servo, like the Hitec HS-311. The parts that can be constructed using a 3D-printer, are presented in section 5.4. As you can see below, the three tables contain the names of the Solidworks part files, as well as their quantity and usage. To facilitate the identification of each part, we also provide images of the models.

5.1 Robot Finger

Robot Finger		
Part Name	Qty	Description
FingerBase1	8	Acrylic Part for Finger Base
FingerBase2	4	Acrylic Part for Finger Base
FingerBase3	4	Acrylic Part for Finger Base
FingerMCP	4	Acrylic Part for MCP
FingerPIP	4	Acrylic Part for PIP
FingerDIP	4	Acrylic Part for DIP
TubeplateMCP	8	Acrylic Part for Base of Tubes for MCP
Tubeplate	12	Acrylic Part for Base of Tubes for Phalanges
tubeMCP	8	Cotton Swab Tube for MCP [d:2mm, D:2.5mm, L:8mm]
tubePIP	8	Cotton Swab Tube for PIP [d:2mm, D:2.5mm, L:26mm]
tubeDIP	8	Cotton Swab Tube for DIP [d:2mm, D:2.5mm, L:10mm]
Joint1	4	Silicone Sheet, 60A Durometer [(35x18x3)mm]
Joint2	4	Silicone Sheet, 60A Durometer [(39x18x4)mm]
M3Washer	20	Fastener
M3x12	8	Fastener
M3Nut	9	Fastener
pulley	4	V-Groove Sealed Ball Bearing [d:3mm, D:12mm, B:4mm, Deepness:1.2mm]
Dyneema Fishing Line	1	Tendon Routing [D:0.4mm, Strength:41.5kg]
Rubber Foam Tape	1	[Width:10mm, Thickness:4mm]
Anti-Slip Tape	1	3M Gripping Material [Width:25mm]
Self-Adhesive Tape	1	3M Scotch 23 [Width:20mm]

Parts



FingerBase1



FingerBase2



FingerBase3



FingerMCP

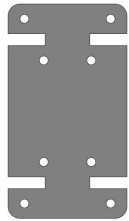

FingerPIP



FingerDIP



TubeplateMCP



Tubeplate



tubes

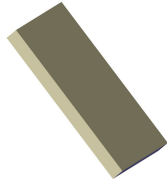

Joint1, Joint2



M3Washer

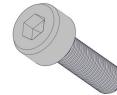

M3x12



M3Nut



pulley

5.2 Robot Hand Base for AX12 Servo

Robot Hand Base for AX12 Servo		
Part Name	Qty	Description
TopPlate	2	Acrylic Part of Robot Hand Base
MiddlePlate	1	Acrylic Part of Robot Hand Base
DifferentialDisk	2	Acrylic Part of Differential Mechanism
BottomPlateAX12	2	Acrylic Part of Robot Hand Base
BearingBase	4	Acrylic Part of Robot Hand Base
AX12Base	1	Acrylic Part of Actuator Base
flangeAX12 #1	1	Acrylic Part of Flange
flangeAX12 #2	1	Acrylic Part of Flange
flangeAX12 #3	1	Acrylic Part of Flange
servoPulleyAX12 #1	1	Acrylic Part of Actuator Pulley
servoPulleyAX12 #2	1	Acrylic Part of Actuator Pulley
servoPulleyAX12 #3	1	Acrylic Part of Actuator Pulley
PCBMount	1	Acrylic Part for PCB
Dyneema Fishing Line	1	Tendon Routing [D:0.4mm, Strength:41.5kg]
Rubber Foam Tape	1	Tape for Fingertips [Width:10mm, Thickness:4mm]
Anti-Slip Tape	1	3M Gripping Material [Width:25mm]
AX12	1	Robotis Actuator Dynamixel AX-12A
pulley	1	V-Groove Sealed Ball Bearing [d:3mm, D:12mm, B:4mm, Deepness:1.2mm]
PlasticSpacer	2	Fastener [d:3.1mm, D:6mm, L:2mm]
M3Spacer30	8	Fastener, Spacer M3 [L:30mm]
M3Spacer25	4	Fastener, Spacer M3 [L:25mm]
M3Spacer10	4	Fastener, Spacer M3 [L:10mm]
M3ThreadedRod	4	Fastener, M3 Threaded Rod [L:20mm]
M3x10	16	Fastener, M3 [L:10mm]
M3x20	1	Fastener, M3 [L:20mm]
M3Washer	13	Fastener, M3 [D:7.5, L:0.5mm]
M3Nut	1	Fastener, M3 Hex Nut
M2x8	8	Fastener, M2 [L:8mm]
M2x6	2	Fastener, M2 [L:6mm]
M2Nut	8	Fastener, M2 Hex Nut
M2.5x15	1	Fastener, M2.5 for AX12 [L:15mm]

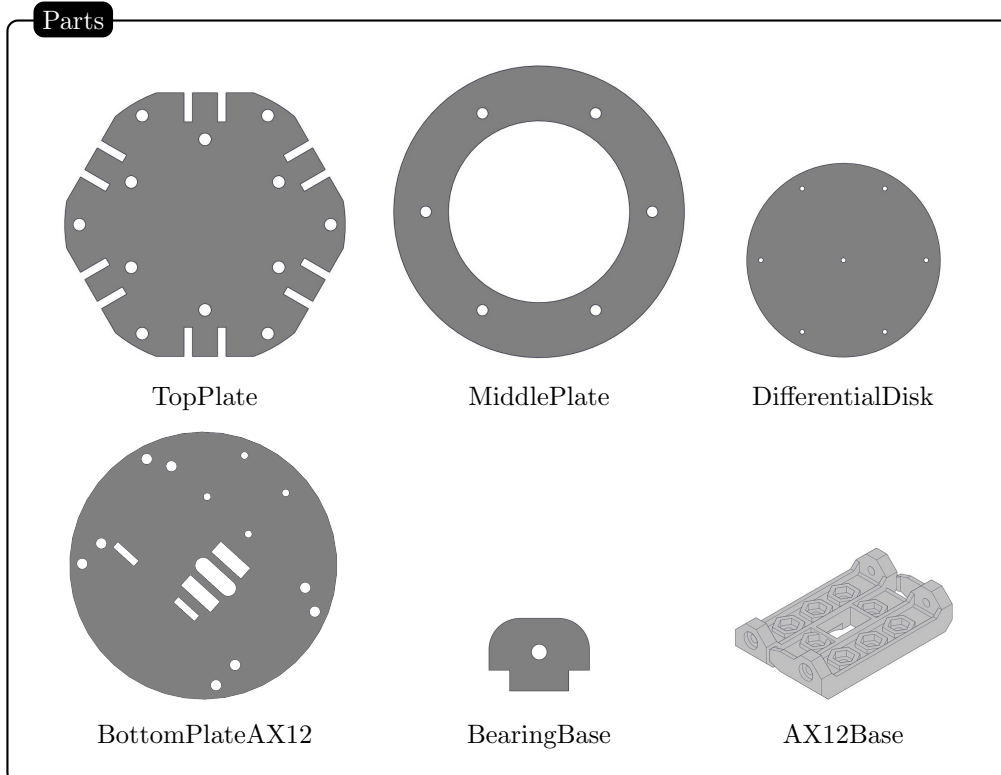

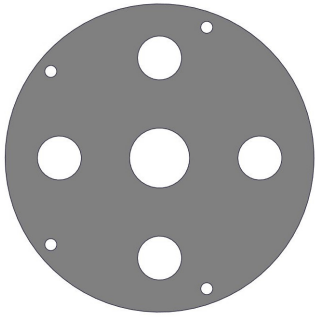

flangeAX12 #1

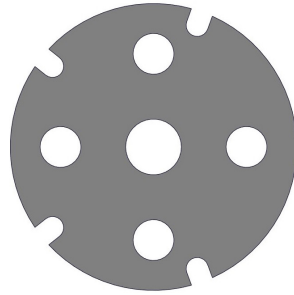

flangeAX12 #2

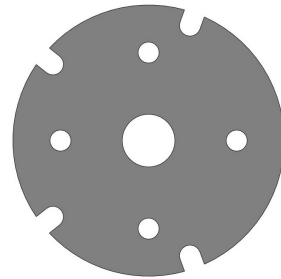

flangeAX12 #3

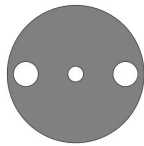

servoPulleyAX12 #1



servoPulleyAX12 #2

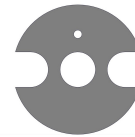

servoPulleyAX12 #3



PCBMount



pulley



PlasticSpacer



M3Spacer30, M3Spacer25



M3Spacer10



M3ThreadedRod

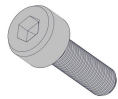

M3x10, M3x20



M3Washer



M3Nut

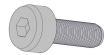

M2x6, M2x8



M2Nut

5.3 Robot Hand Base for Standard Servo

Robot Hand Base for Standard Servo		
Part Name	Qty	Description
TopPlate	2	Acrylic Part of Robot Hand Base
MiddlePlate	1	Acrylic Part of Robot Hand Base
DifferentialDisk	2	Acrylic Part of Differential Mechanism
BottomPlateStdServo	2	Acrylic Part of Robot Hand Base
BearingBase	4	Acrylic Part of Robot Hand Base
stdServoBase	6	Acrylic Part of Actuator Base
flangeStdServo #1	1	Acrylic Part of Flange
flangeStdServo #2	1	Acrylic Part of Flange
flangeStdServo #3	1	Acrylic Part of Flange
servoPulleyStd #1	1	Acrylic Part of Actuator Pulley
servoPulleyStd #2	1	Acrylic Part of Actuator Pulley
servoPulleyStd #3	1	Acrylic Part of Actuator Pulley
PCBMount	1	Acrylic Part for PCB
Dyneema	1	Tendon Routing [D:0.4mm, Strength:41.5kg]
Rubber Foam Tape	1	[Width:10mm, Thickness:4mm]
Anti-Slip Tape	1	3M Gripping Material [Width:25mm]
Hitec HS-311	1	Actuator
pulley	1	V-Groove Sealed Ball Bearing [d:3mm, D:12mm, B:4mm, Deepness:1.2mm]
PlasticSpacer	2	Fastener [d:3.1mm, D:6mm, L:2mm]
M3Spacer30	8	Fastener, Spacer M3 [L:30mm]
M3Spacer25	4	Fastener, Spacer M3 [L:25mm]
M3Spacer10	4	Fastener, Spacer M3 [L:10mm]
M3ThreadedRod	4	Fastener, M3 Threaded Rod [L:20mm]
M3x10	16	Fastener, M3 [L:10mm]
M3x12	6	Fastener, M3 [L:10mm]
M3x20	1	Fastener, M3 [L:20mm]
M3Nut	7	Fastener, M3 Hex Nut
M3Washer	18	Fastener, M3 [D:7.5mm, L:0.5mm]

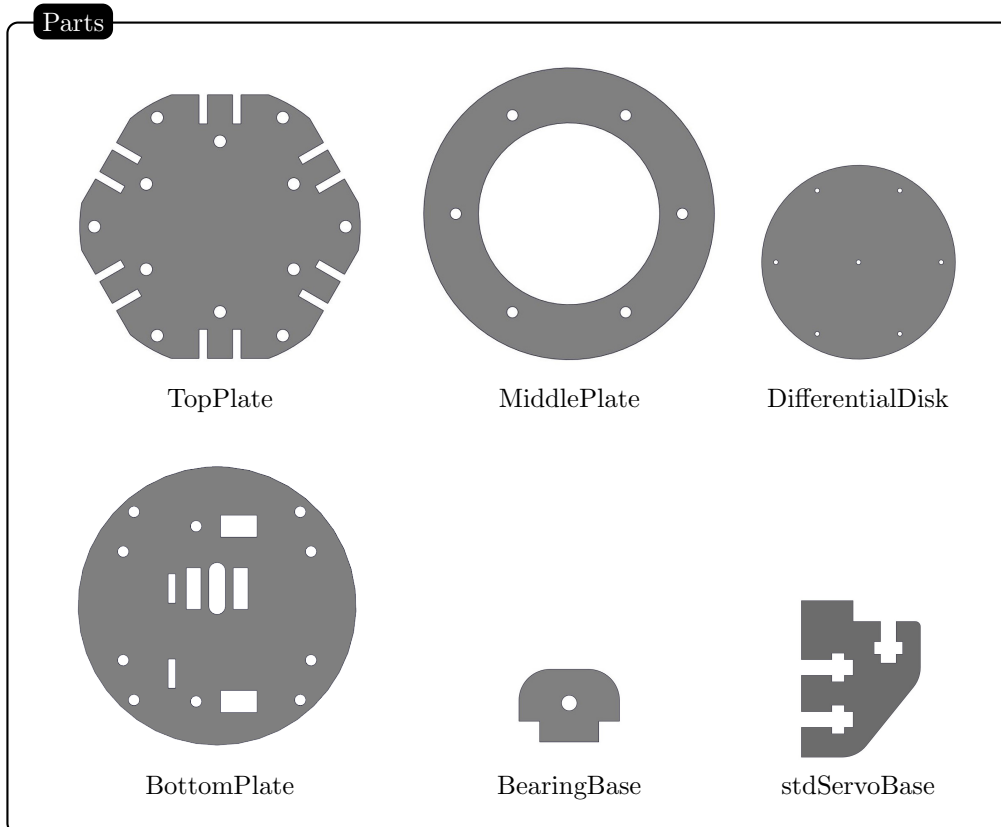

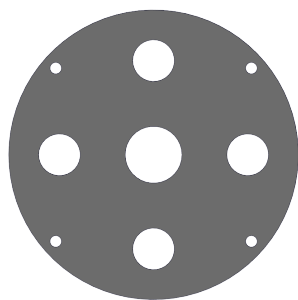

flangeStdServo #1

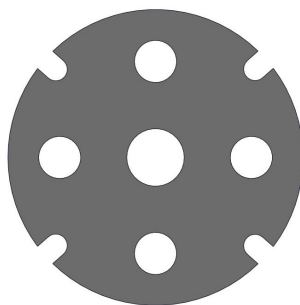

flangeStdServo #2

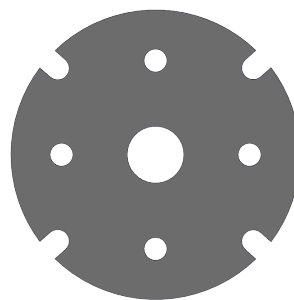

flangeStdServo #3



servoPulleyStd #1



servoPulleyStd #2



servoPulleyStd #3



PCBMount



pulley



PlasticSpacer

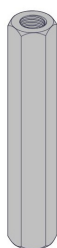

M3Spacer25, M3Spacer30



M3Spacer10



M3ThreadedRod

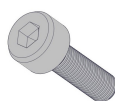

M3x10, M3x12, M3x20



M3Nut



M3Washer

5.4 3D Printer Parts

The proposed robot hands can also be created with other materials like ABS, using 3D printing. The STL files in the CAD directory, are appropriate to be used with a 3D printer. The following table contains the required parts, as well as the names of the standard parts that they replace.

3D Printer Parts	
Part Name	Replacing Parts
FingerBase	FingerBase1, FingerBase2, FingerBase3, FingerMCP, TubePlateMCP parts
FingerPIP	FingerPIP, TubePlate parts
FingerDIP	FingerDIP, TubePlate parts
TopPlate	TopPlate parts
MiddlePlate	MiddlePlate part
DifferentialDisk	DifferentialDisk parts
BottomPlateStdServo	BottomPlateStdServo, BearingBase parts
stdServoBase	stdServoBase parts
FlangeStdServo	flangeStdServo #1, flangeStdServo #2, flangeStdServo #3 parts
BottomPlateAX12	BottomPlateAX12, BearingBase parts
FlangeAX12	flangeAX12 #1, flangeAX12 #2, flangeAX12 #3 parts
servoPulleyStd #1-2	servoPulleyStd #1, servoPulleyStd #2 parts
servoPulleyStd #3	servoPulleyStd #3 part
servoPulleyAX12 #1-2	servoPulleyAX12 #1, servoPulleyAX12 #2 parts
servoPulleyAX12 #3	servoPulleyAX12 #3 parts
PCBMount	PCBMount part

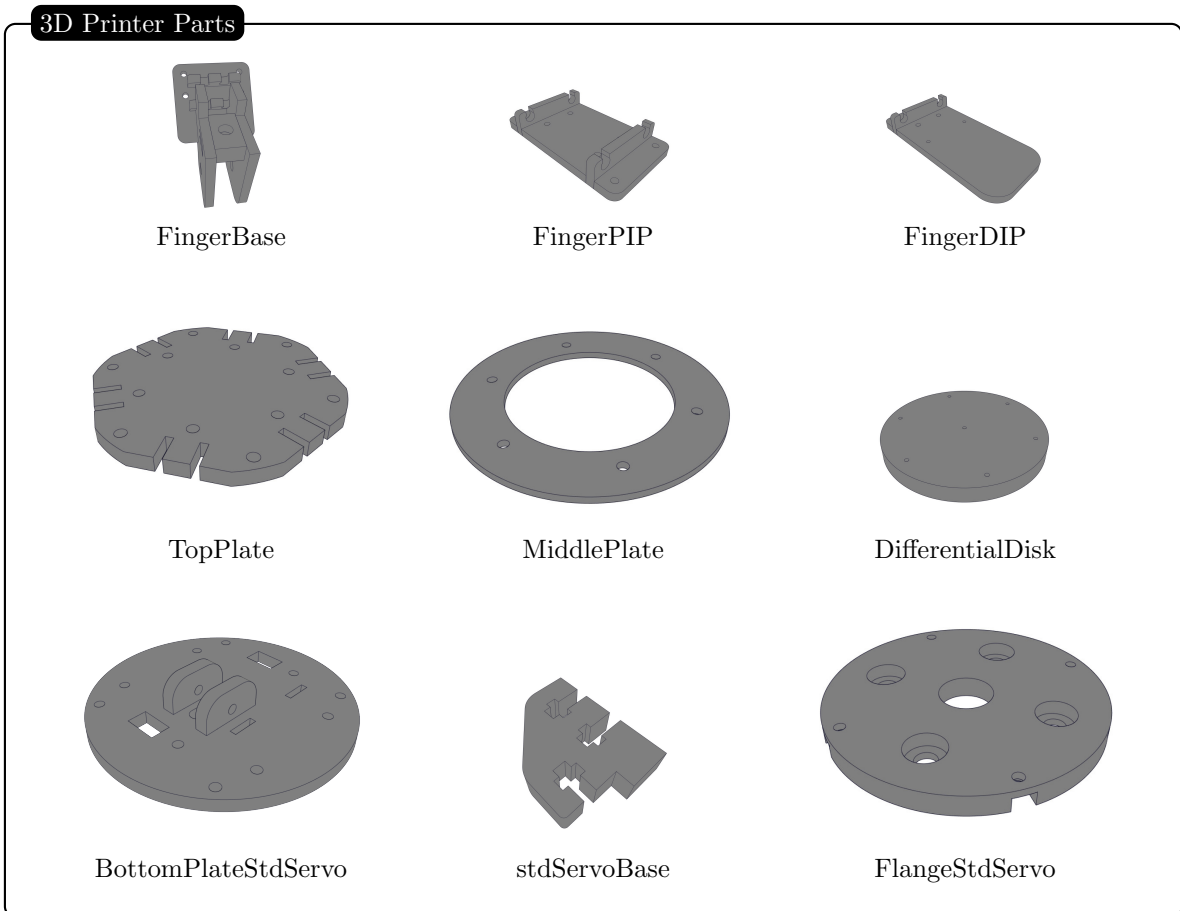

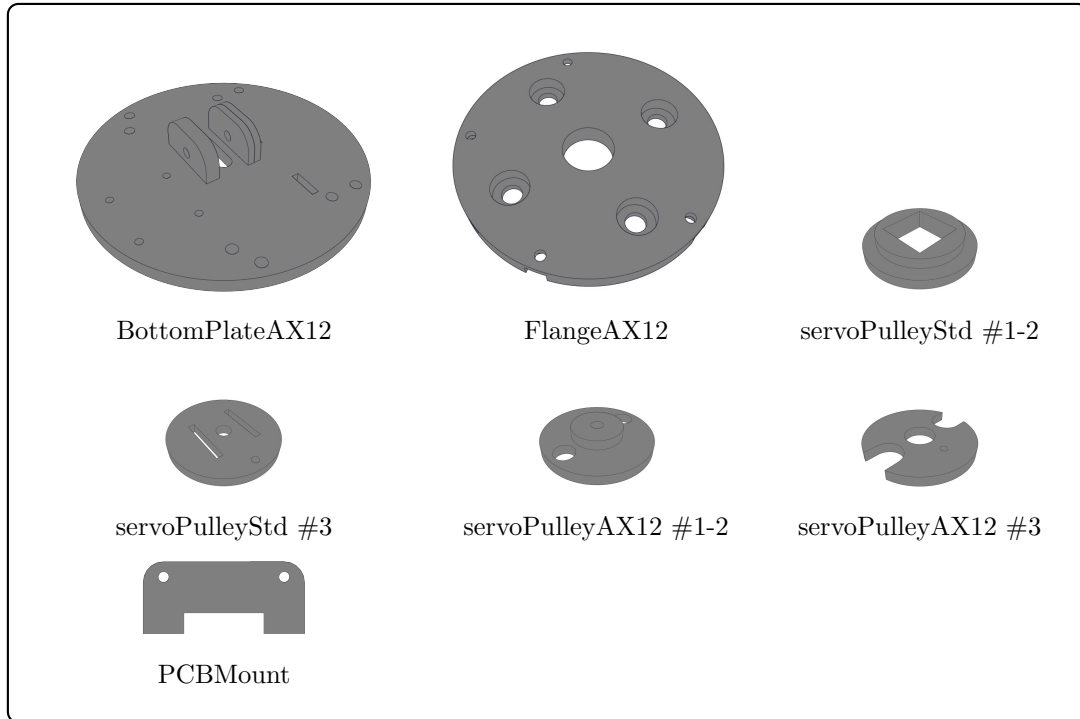

In order to print the required parts we use the LulzBot AO-100 Desktop 3D Printer. The Slic3r (a G-code generator) printer settings are shown in the following table. The settings are also contained in a file named RobotHand.ini.

3D Printer Settings	
Parameter	Value
Layer Height	0.4022
First Layer Height	100%
Solid Layers, Top	3
Solid Layers, Bottom	3
Infill, Fill Density	40%
Infill, Fill Pattern	Honeycomb
Infill, Top/Bottom Fill Pattern	Rectilinear
Brim, Brim Width	2 mm
Support Material, Pattern	Pillars
Support Material, Pattern Spacing	2.5mm
Support Material, Pattern Angle	0 deg
Support Material, Interface Layers	3 layers
Support Material, Interface Pattern Spacing	0mm

5.5 Before Building

Before starting the construction of the robot hand you must prepare the parts and pay attention to the steps provided below:

- Smooth the acrylic parts with sandpaper.
- Treat the ABS parts with acetone (more information: RepRap: Blog).
- Cut the cotton swabs, to the appropriate size (following the parts reference dimensions).
- Cut the silicone sheets, to the appropriate size (following the parts reference dimensions).
- Group the parts according to the parts reference.
- Pay always attention to the details having the following icon ⚠.
- Please note that the provided models do not have the actual size of the parts.

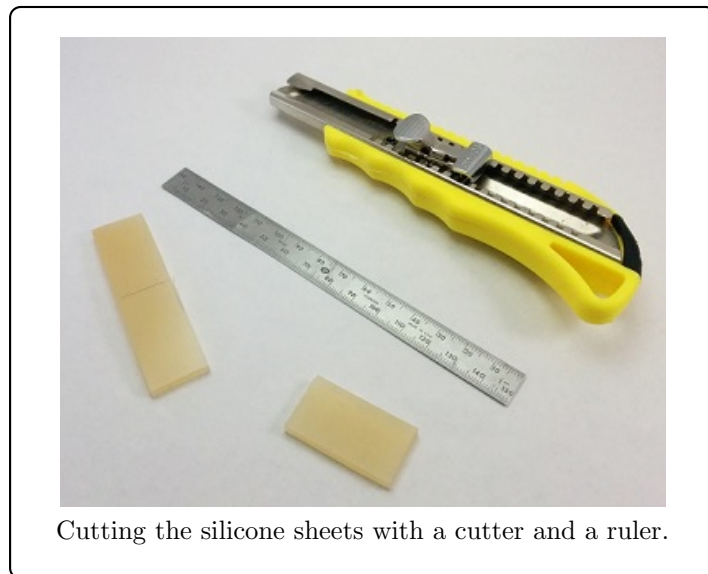

Cutting the silicone sheets with a cutter and a ruler.

6 Robot Finger

6.1 Prepare Parts for the Robot Finger

Part	Qty
FingerBase1	8
FingerBase2	4
FingerBase3	4
FingerMCP	4
TubePlateMCP	8
FingerPIP	4
FingerDIP	4
Tubeplate	12
tubeMCP	8
tubePIP	8
tubeDIP	8
M3x12	4
M3Washer	16
M3Nut	4
pulley	4

Tools
Acrylic Glue
Super Glue
Allen Wrench 2.5mm
Open-End Wrench

6.1.1

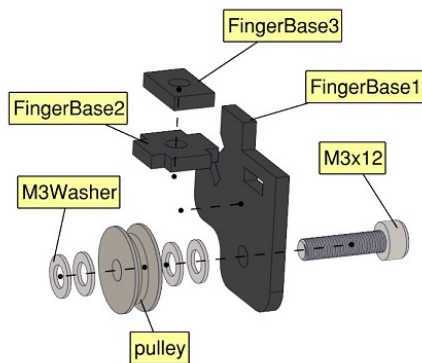

- ① Glue FingerBase2 and FingerBase3 together using acrylic glue.
- ② Glue FingerBase1 and FingerBase2-3 together using acrylic glue.
- ③ Continue as you see in the picture.
- ④ Pay attention not to forget the M3 washers.

6.1.2

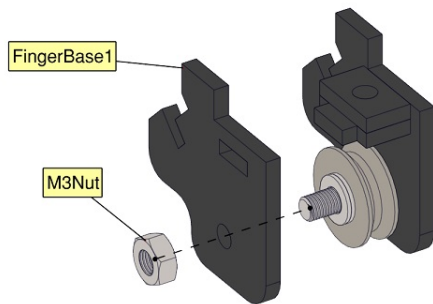

- ① Attach FingerBase1 to the previous part.
- ② Glue the previous part and FingerBase1 together using acrylic glue.
- ③ Screw the M3Nut to the M3x12 screw.
- ④ M3 washers must be in the right position.
- ⑤ Tighten the screw until the pulley can freely move.

6.1.3

- ① Glue FingerMCP and TubePlateMCP parts together, using acrylic glue.

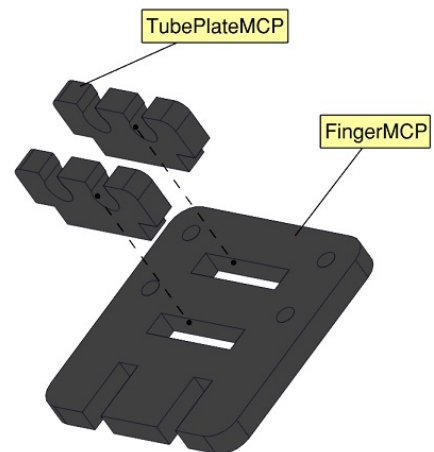

6.1.4

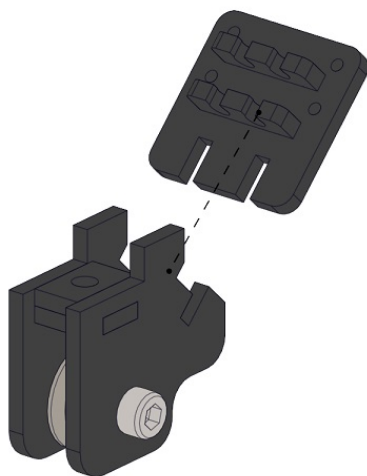

- ① Attach the FingerMCP part to the FingerBase1 slots.
- ② The FingerMCP part must fit into the FingerBase1 slots.
- ③ Glue the two parts together with acrylic glue.

6.1.5

- ① Insert the low friction tubes to the tube plates, as you see in the picture.
- ② Glue the edges of the tubes to the tube plate, using super glue.

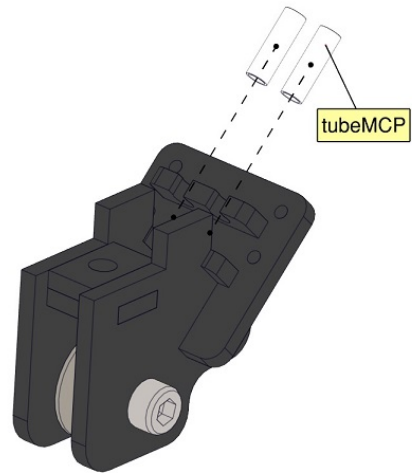

FingerBase part

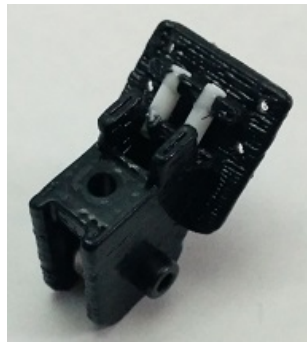

6.1.6

- ① Glue FingerPIP and TubePlate together, using acrylic glue.

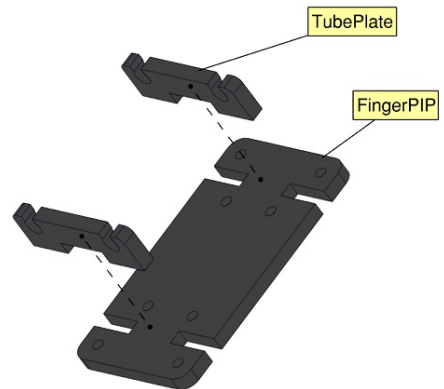

6.1.7

- ① Insert the low friction tubes to the tube plates, as you see in the picture.
- ② Glue the edges of the tubes to the tube plate, using super glue.

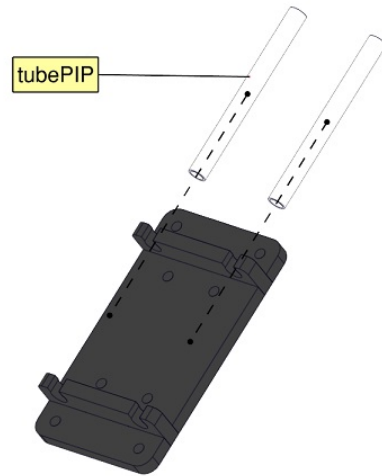

6.1.8

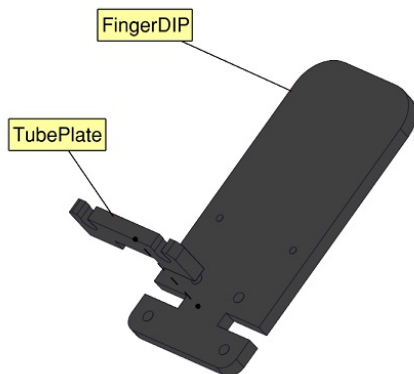

- ① Glue FingerDIP and TubePlate together, using acrylic glue.

6.1.9

- ① Insert the low friction tubes to the tube plates, as you see in the picture.
- ② Glue the edges of the tubes to the tube plate, using super glue.

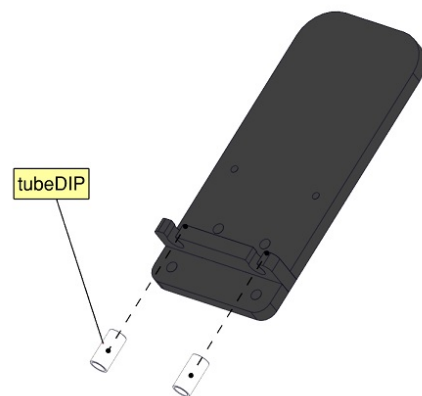

FingerPIP and FingerDIP parts

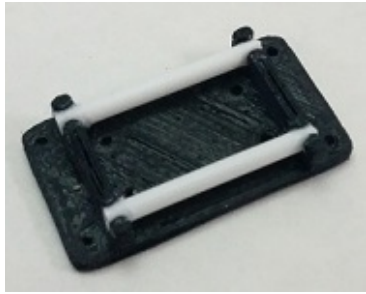

6.2 Stitching the Rigid Parts onto the Flexure Joints

Part	Qty
FingerBase	4
FingerPIP	4
FingerDIP	4
Joint1	4
Joint2	4

Tools
Long Darners
Nylon Fishing Line
Cutter
Long-Nose Pliers with Side-Cutting
Precision Ruler
Scissors

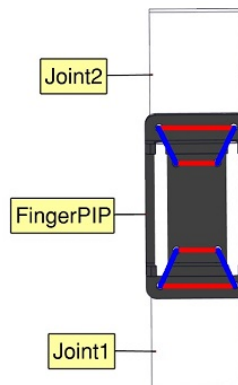
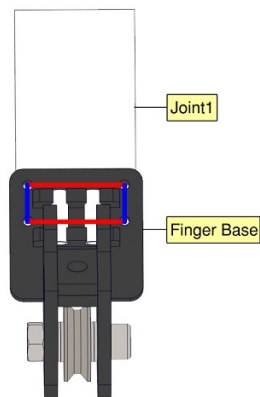

In order to connect together the rigid parts that we assembled in the previous sections, we use silicone sheets as flexure joints. These silicone sheets can be stitched onto the rigid parts, following the pattern that you see in the picture. This sewing pattern creates a rigid connection between the rigid part and the flexure joint.

We use nylon fishing line and long darners for sewing. In the picture, the red lines depict a fishing line passing from both sides of the rigid part and the flexure joint, while the blue lines depict a fishing line that passes only from the lower side of the flexure joint. The same sewing pattern can be used for both fingerPIP and fingerDIP parts. The following steps explain exactly this process.

6.2.1

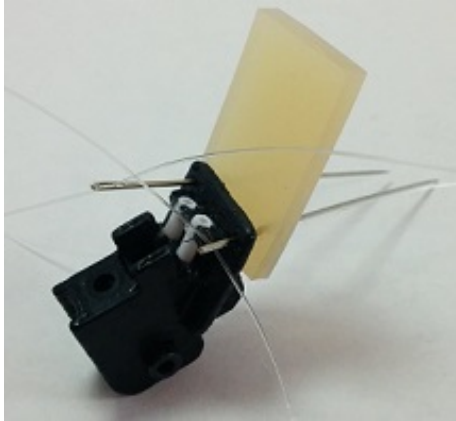

- ① Cut a 450mm fishing line.
- ② Insert the fishing line to the holes of two long darners.
- ③ Insert from the outer holes of the upper side of the fingerMCP part the two long darners, as you see in the picture.

6.2.2

- ① Insert each of the darners, to the hole of the other darning.
- ② Repeat ① 2 times.
- ③ The darners are now in the lower side of the fingerMCP part.
- ④ Insert the darners to the inner holes of the fingerMCP part.

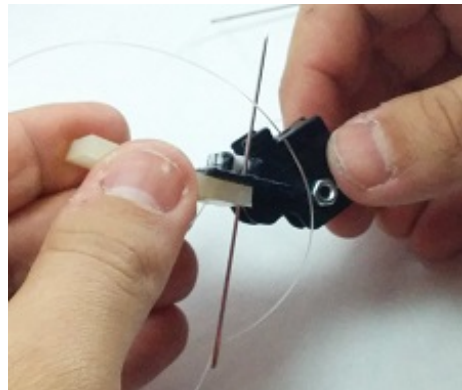

6.2.3

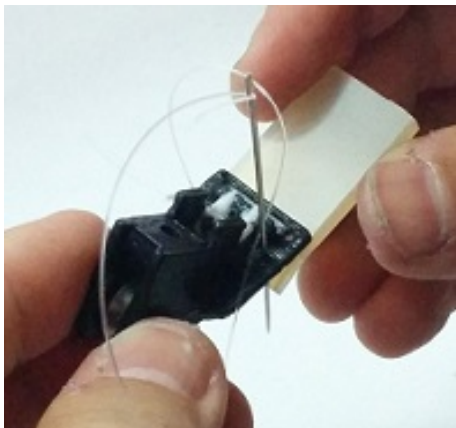

- ① Insert each one of the darners to the hole of the other darning.
- ② Repeat ① 3 times.
- ③ The darners are now in the lower side of the fingerMCP part.

6.2.4

- ① Remove the darners from the fishing line.
- ② With the two ends of the fishing line do multiple surgeon's knots.



6.2.5

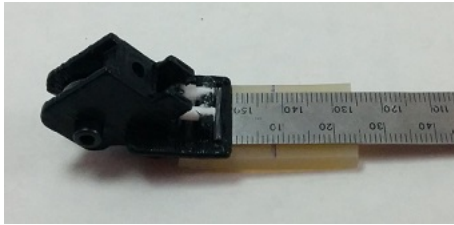

- ① Use a ruler to measure 8mm from the edge of the fingerMCP part and draw a line with a pen.

6.2.6

- ① Cut a 450mm fishing line.
- ② Insert the fishing line to the holes of two long darners.
- ③ Center the fingerPIP part with the silicone part and align it with the line from the previous step.
- ④ Insert from the outer holes of the lower side of the fingerPIP part the two long darners, as you see in the picture.

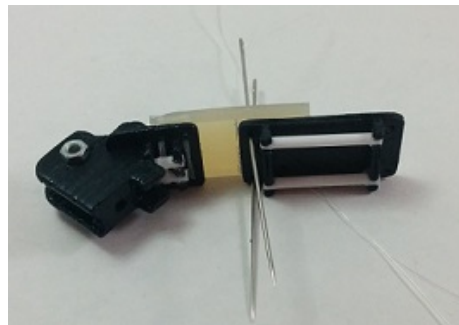

6.2.7

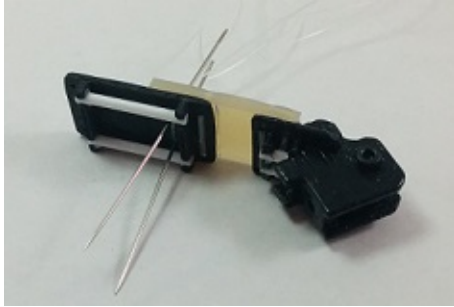

- ① Insert each one of the darners to the hole of the other darning.
- ② Repeat ① for 3 times.
- ③ The darners are now in the lower side of the fingerPIP part.

6.2.8

- ① Insert the darners to the inner holes of the fingerPIP part from the lower side.
- ② Insert each one of the darners to the hole of the other darning.
- ③ Repeat ② 3 times.
- ④ The darners are now in the lower side of the fingerPIP part.
- ⑤ Remove the darners from the fishing line.
- ⑥ With the two ends of the fishing line do multiple surgeon's knots.

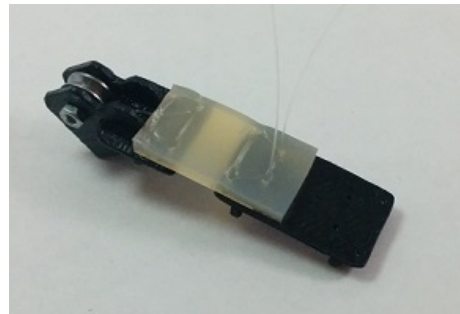

Robot Finger

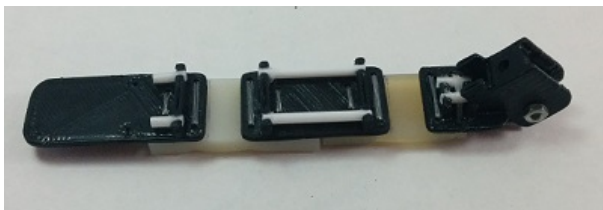

- ① Repeat the 6.2.6 - 6.2.8 steps for the FingerDIP part.
- ② Congratulations, now you have a robot finger!

6.3 Tendon Routing of the Robot Finger

Part	Qty
Robot Finger	4
Dyneema	-

Tools
Scissors
Precision Ruler

6.3.1

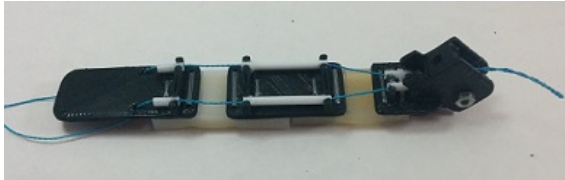

- ① Cut 600mm of the Dyneema fishing line.
- ② Insert the Dyneema into the low friction tubes starting from the tubeMCP.

6.3.2

- ① Now the two edges of the Dyneema are at the end of the tubeMCP.
- ① Use a M3 spacer of 10mm length as depicted in the picture.

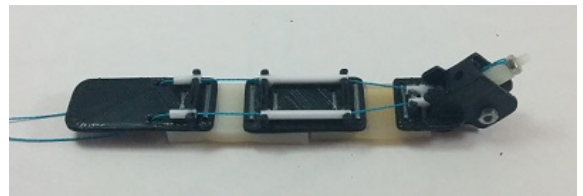

6.3.3

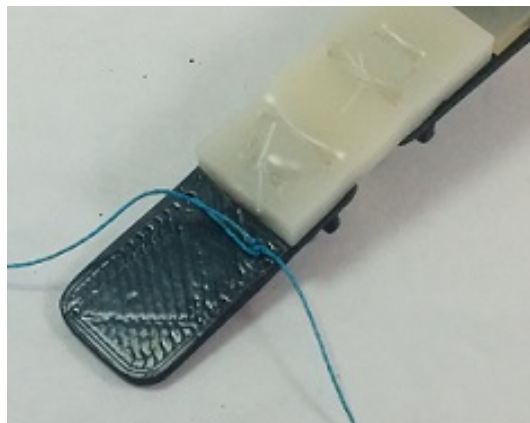

- ① With the two edges of the Dyneema do multiple surgeon's knots.

6.4 Install Soft Fingetips

Part	Qty
Robot Finger	4
Sponge Tape	-
Self-adhesive Tape	-
Anti-Slip Tape	-

Tools
Scissors

6.4.1



- ① Cut two pieces of 24mm sponge tape.
- ② Set the two pieces onto the FingerPIP part.

6.4.2

- ① Cut a piece of 130mm self-adhesive tape.
- ② Wrap the tape around the FingerPIP part.



6.4.3



- ① Cut two pieces of 32mm sponge tape.
- ② Set the two pieces onto the FingerDIP part.
- ③ Cut a piece of 10mm sponge tape.
- ④ Set the sponge tape onto the empty space of the FingerDIP part.
- ⑤ Cut two pieces of 40mm sponge tape and set them onto the other side.

6.4.4

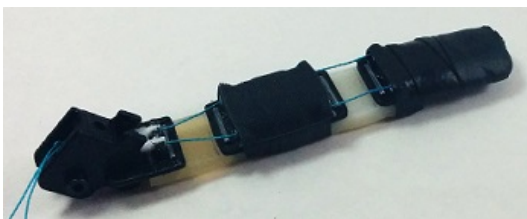

- ① Cut a piece of 200mm self-adhesive tape.
- ② Wrap the tape around the FingerDIP part.

6.4.5

- ① Cut a piece of 27mm anti-slip tape.
- ② Attach the tape onto the FingerPIP part.
- ③ Cut a piece of 40mm anti-slip tape.
- ④ Attach the tape onto the FingerDIP part.
- ⑤ Cut the edges of the tape at the FingerDIP part.

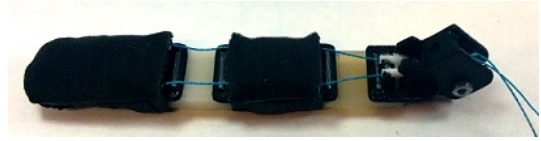

6.5 Install Soft Pad to the Top Plate of the Robot Base

Part	Qty
TopPlate	2
Sponge Tape	-
Anti-Slip Tape	-

Tools
Acrylic Glue
Scissors

6.5.1

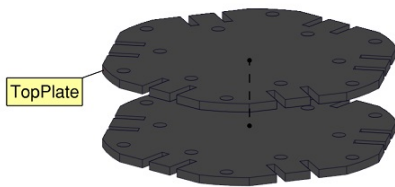

- ① Glue the TopPlate parts.
- ② Center the two parts as depicted.

6.5.2

- ① Cut three pieces of 25mm sponge tape.
- ② Put the pieces of tape in the middle of the TopPlate part.

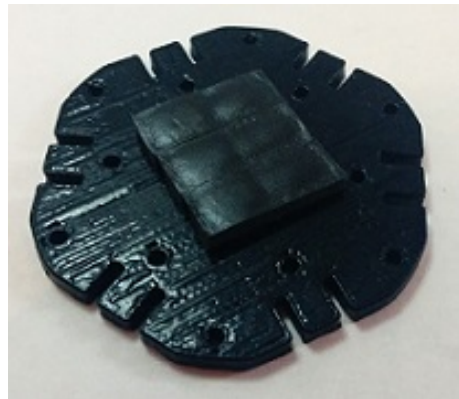

6.5.3

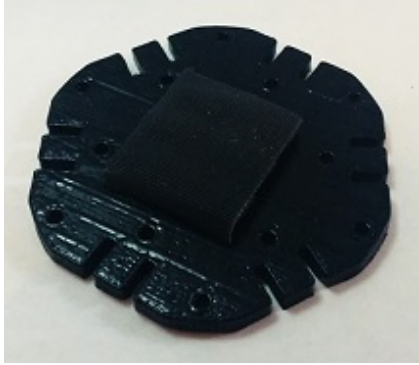

- ① Cut a piece of 32mm anti-slip tape.
- ② Attach the tape pieces onto the sponge tape.

6.6 Install the Robot Fingers to the TopPlate

Part	Qty
TopPlate	1
Robot Finger	4
M3x12	4
M3Washer	4
M3Nut	5

Tools
Allen Wrench 2.5mm

6.6.1

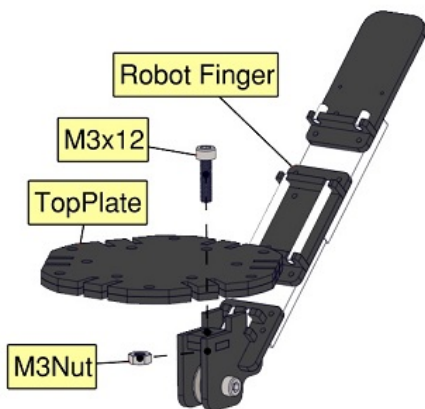

- ① Keep the TopPlate part and the robot finger.
- ② Insert the M3Nut in the FingerBase part.
- ③ Insert the robot finger to the slot of the TopPlate.
- ④ Center the M3Nut with the holes of the FingerBase and the TopPlate parts.
- ⑤ Insert the M3x12 screw with the M3 washer in the hole of the TopPlate.
- ⑥ Tighten the M3x12 screw.
- ⑦ Repeat the steps to install all the robot fingers to the TopPlate.

TopPlate with Robot Finger

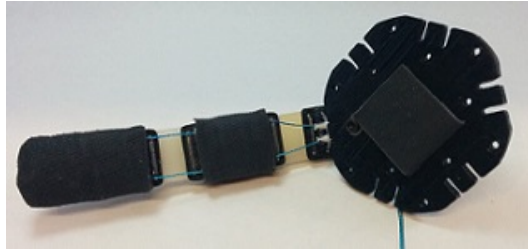

6.6.2

- ① Cut 20mm of Dyneema fishing line.
- ② Pass the Dyneema fishing line through the FingerBase tendon loop or spacer.
- ① Leave both edges of the Dyneema free!
- ③ Repeat the steps for all robot fingers.

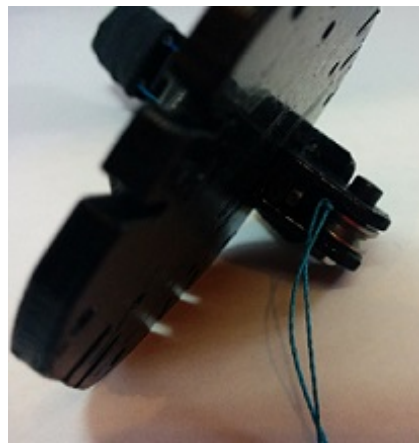

6.6.3

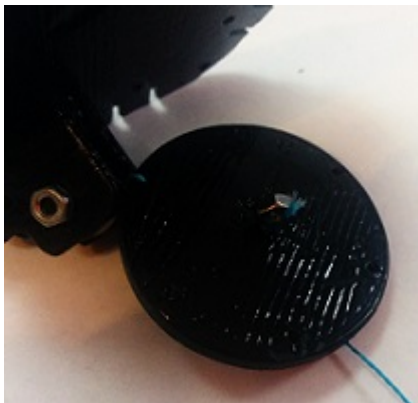

- ① Cut 400mm of Dyneema fishing line.
- ② Pass the Dyneema from the hole of a M3 nut and do a non-slip knot.
- ③ Insert the Dyneema into the centered hole of the differential mechanism.
- ① The nut will keep the Dyneema constrained at the one side!

6.6.4

- ① Center the holes of the differential disk with the TopPlate slots.
- ② Insert one edge of the FingerBase Dyneema into one of the holes of the differential.
- ③ With the two edges of the Dyneema do multiple surgeon's knots.
- ④ Repeat the steps for all robot fingers.

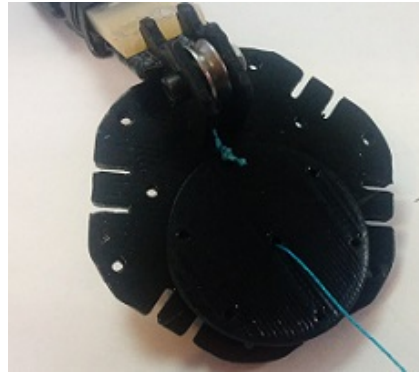

7 Robot Hand Base

7.1 Middle Plate

Part	Qty
MiddlePlate	1
M3Spacer30	8
M3ThreadedRod	4

Tools
Open-End Wrench

7.1.1

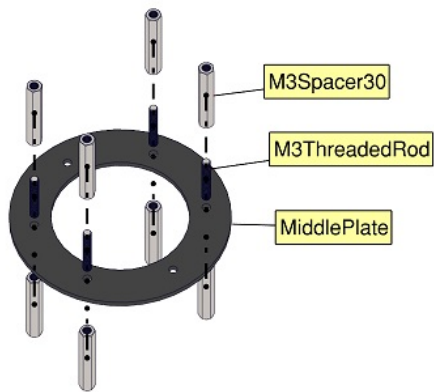

- ① Tighten the M3ThreadedRod until the midway (12mm).
- ② Continue as you see in the picture.

7.2 Bearing Base

Part	Qty
BearingBase	4
pulley	1
M3x20	1
M3Washer	3
PlasticSpacer	2
M3Nut	1

Tools
Open-End Wrench
Acrylic Glue
Allen Wrench

7.2.1

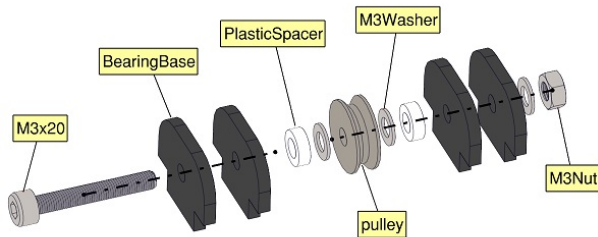

- ① Center the two BearingBase parts.
- ② Glue the two BearingBase parts.
- ③ Repeat the same steps for the second BearingBase.

7.3 Bottom Plate with AX12 Servo

Part	Qty
BearingBase	4
BottomPlateAX12	2
PCBMount	1
AX12Base	1
M2x8	4
M2Nut	4

Tools
Open-End Wrench
Acrylic Glue
Allen Wrench

7.3.1

- ① Center the two BottomPlate parts.
- ② Glue the two BottomPlate parts.
- ③ Glue the BearingBase to the BottomPlateAX12 with acrylic glue.
- ④ Glue the PCBMount to the BottomPlateAX12.

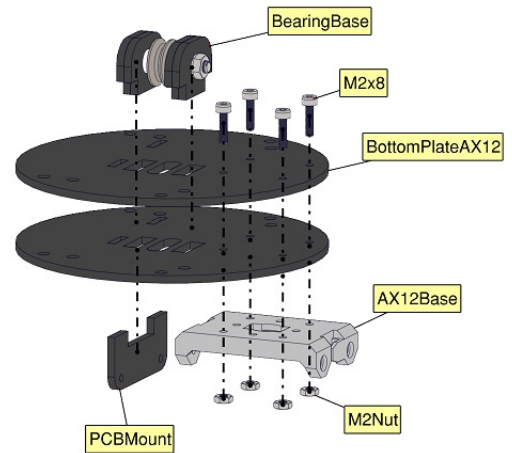

7.4 Bottom Plate with Standard Servo

Part	Qty
BottomPlateStdServo	2
BearingBase	1
stdServoBase	6
PCBMount	1
M3x12	2
M3Washer	2
M3Nut	2

Tools
Allen Wrench
Acrylic Glue

7.4.1

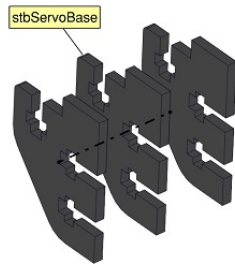

- ① Center the two stdServoBase parts.
- ② Glue the two stdServoBase parts.
- ③ Center the third stdServoBase part with the other two.
- ④ Glue the third stdServoBase part with the other two.

7.4.2

- ① Center the BottomPlateStdServo as you see in the picture.
- ② Glue the two parts with acrylic glue.
- ③ Center the BearingBase with the BottomPlateStdServo as you see in the picture.
- ④ Glue the two parts with acrylic glue.
- ⑤ Glue the PCBMount to the BottomPlateStdServo.
- ⑥ Continue as you see in the picture.

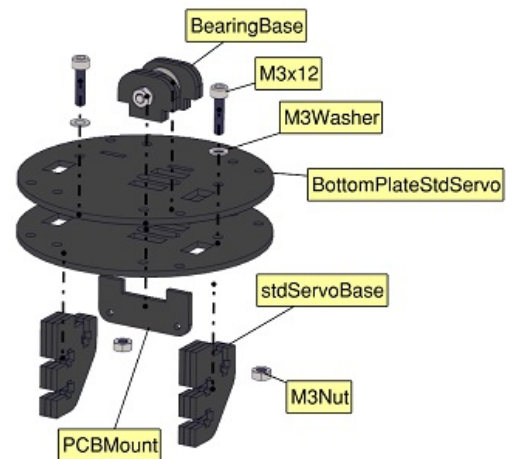

7.5 Robot Base with AX12 Servo

Part	Qty
MiddlePlate	1
BottomPlateAX12	1
FingersTopPlate	1
M3x10	8
M3Washer	8

Tools
Open-End Wrench
Allen Wrench

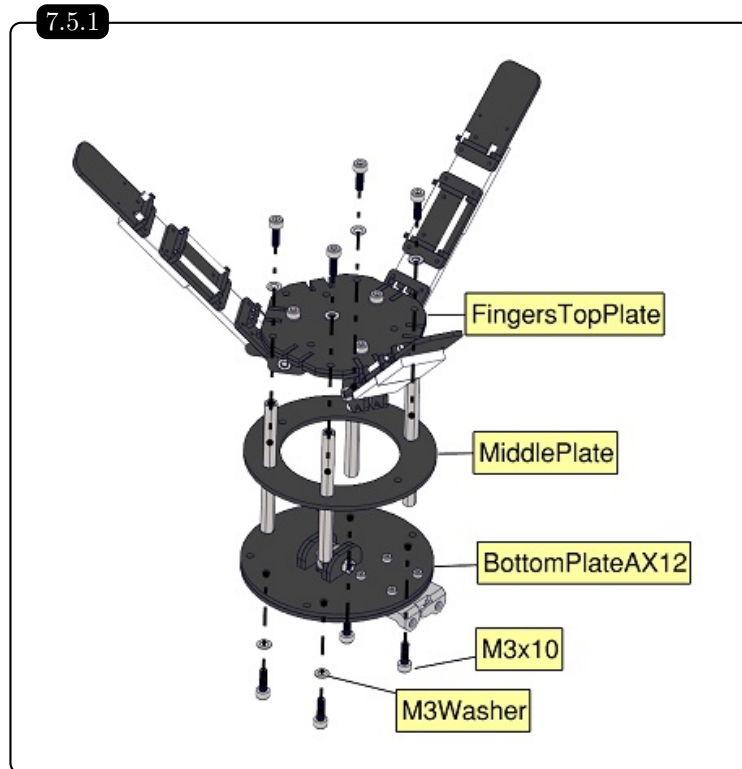

7.6 Robot Base with Standard Servo

Part	Qty
MiddlePlate	1
BottomPlateStdServo	1
FingersTopPlate	1
M3x10	8
M3Washer	8

Tools
Open-End Wrench
Allen Wrench

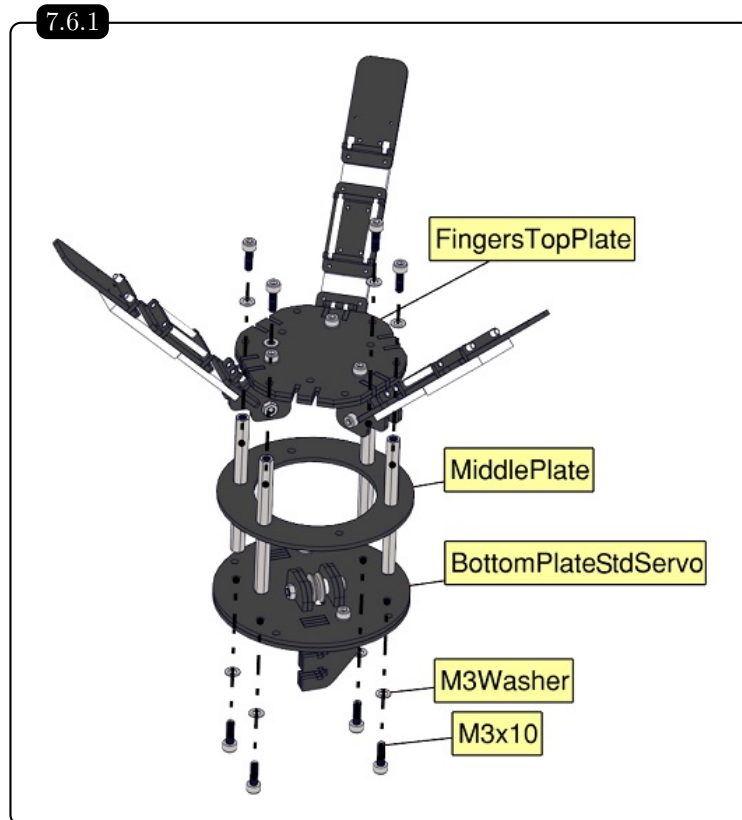

7.7 AX12 Servo

Part	Qty
AX12Base	1
servoPulleyAX12 #1	1
servoPulleyAX12 #2	1
servoPulleyAX12 #3	1
AX12 Servo	1
M2x8	4
M2Nut	4
M2x6	2
M2.5x15	1

Tools
Acrylic Glue
Allen Wrench

7.7.1

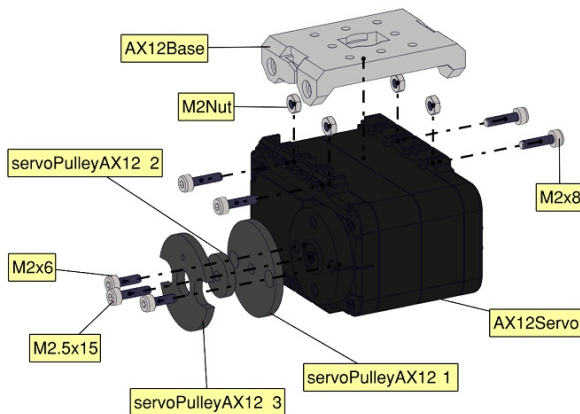

- ① Center the servoPulleyAX12 parts #1,2.
- ② Glue the two parts with acrylic glue.
- ③ Center the servoPulleyAX12 parts #1-2,3.
- ④ Glue the two parts with acrylic glue.
- ⑤ Press all the parts together to achieve better gluing.

7.7.2

- ① Insert a Dyneema edge in the anchor hole.
- ② With the edge of the Dyneema and the M3Nut do multiple surgeon's knots.
- ③ Wrap the dyneema around the servo pulley until taut.
- ④ You can adjust the initial configuration later zeroing the servo motor.
- ⑤ Screw the M2.5x15 to the AX12 servo.



7.8 Standard Servo

Part	Qty
Robot Base StdServo	1
servoPulleyStd1	1
servoPulleyStd2	1
servoPulleyStd3	1
Hitec HS-311	1
servoScrew	1
M3x12	4
M3Washer	4
M3Nut	4

Tools
Acrylic Glue
Allen Wrench

7.8.1

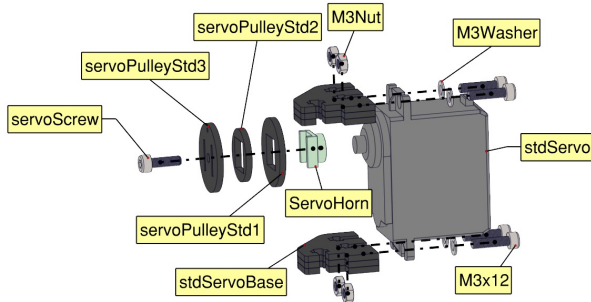

- ① Center the servoPulleyStd parts #1,2.
- ② Glue the two parts with acrylic glue.
- ③ Center the servoPulleyStd parts #1-2,3.
- ④ Glue the two parts with acrylic glue.
- ⑤ Press all parts together to achieve better gluing.
- ⑥ Insert the edge of the Dyneema inside the anchor hole of the servoPulleyStd part #3.
- ⑦ With the edge of the Dyneema and the M3Nut do multiple surgeon's knots.
- ⑧ Wrap the dyneema around the servo pulley until taut.
- ⑨ You can adjust the initial configuration later zeroing the servo motor.
- ⑩ Screw the servoScrew to the Hitec HS-311.

7.9 Robot Flange for Robot Base with AX12 Servo

Part	Qty
flangeAX12 #1	1
flangeAX12 #2	1
flangeAX12 #3	1
M3Spacer10	4
M3Spacer25	4
M3x10	4

Tools
Acrylic Glue
Allen Wrench
Open-End Wrench

7.9.1

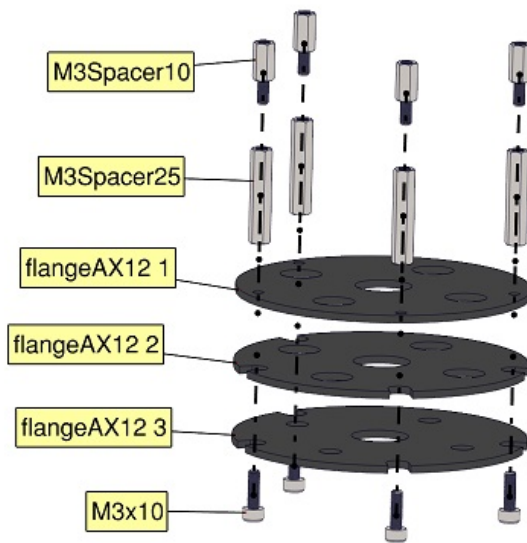

- ① Center the flangeAX12 parts #2,3.
- ② Glue the two parts with acrylic glue.
- ③ Center the flangeAX12 parts #1,2-3.
- ④ Glue the two parts with acrylic glue.

7.10 Robot Flange for Robot Base with Standard Servo

Part	Qty
flangeStdServo #1	1
flangeStdServo #2	1
flangeStdServo #3	1
M3Spacer10	4
M3Spacer25	4
M3x10	4

Tools
Acrylic Glue
Allen Wrench
Open-End Wrench

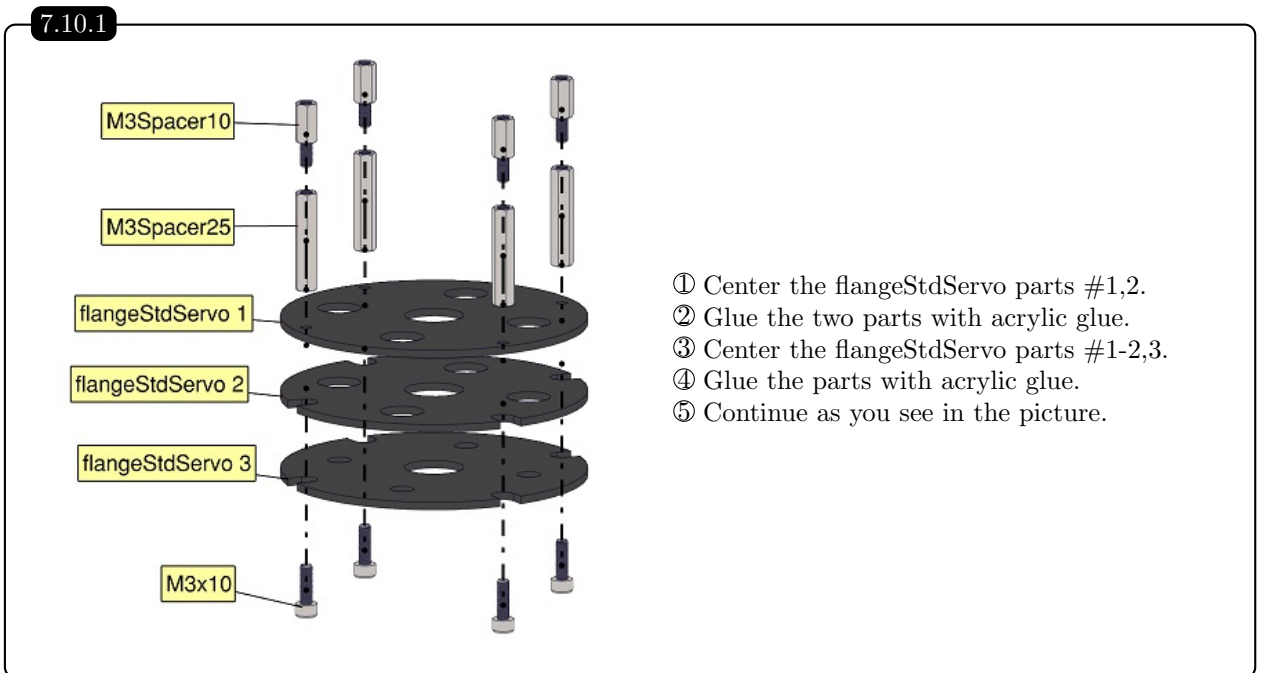

7.11 Final Assembly of Robot Hand with AX12 Servo

Part	Qty
FlangeAX12	1
Robot Hand AX12	1
M3Washer	4
M3x10	4

Tools
Allen Wrench
Open-End Wrench

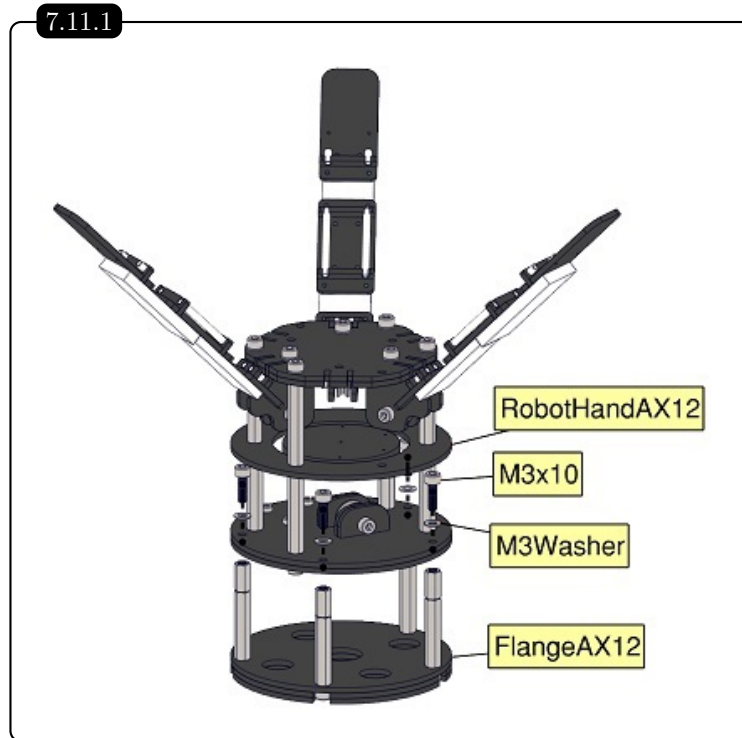

7.12 Final Assembly of Robot Hand with Standard Servo

Part	Qty
FlangeStdServo	1
Robot Hand stdServo	1
M3Washer	4
M3x10	4

Tools
Allen Wrench
Open-End Wrench

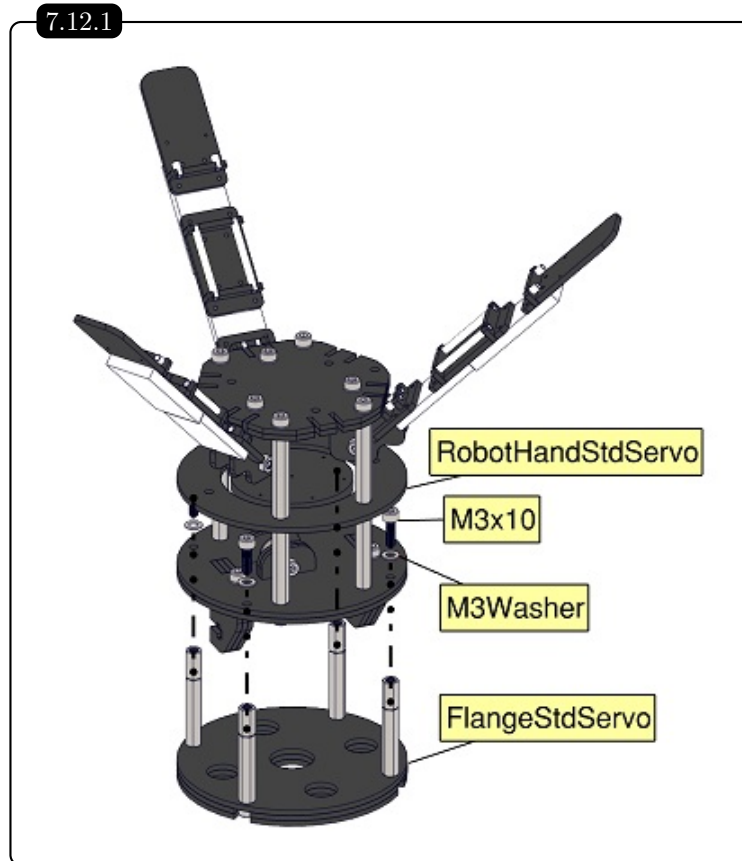

Congratulations you have created a robot hand!!!

Bibliography

- [1] M. V. Liarokapis, A. G. Zisimatos, C. I. Mavrogiannis, and K. J. Kyriakopoulos, “OpenBionics: an open-source initiative for the creation of affordable, modular, light-weight, underactuated robot hands and prosthetic devices,” in *2nd ASU Rehabilitation Robotics Workshop*, February 2014.
- [2] R. Ma, L. Odhner, and A. Dollar, “A modular, open-source 3d printed underactuated hand,” in *IEEE International Conference on Robotics and Automation (ICRA)*, pp. 2737–2743, May 2013.
- [3] A. Zisimatos, M. Liarokapis, C. Mavrogiannis, and K. Kyriakopoulos, “Open-source, affordable, modular, light-weight, underactuated robot hands,” in *IEEE/RSJ International Conference on Intelligent Robots and Systems (IROS)*, pp. 3207–3212, Sept 2014.
- [4] A. Dollar and R. Howe, “A robust compliant grasper via shape deposition manufacturing,” *Mechatronics, IEEE/ASME Transactions on*, vol. 11, no. 2, pp. 154–161, 2006.
- [5] M. Grebenstein, *Approaching Human Performance: The Functionality Driven Awiwi Robot Hand*. PhD thesis, 2012.
- [6] M. T. Ciocarlie, A. T. Miller, and P. K. Allen, “Grasp analysis using deformable fingers,” in *IEEE/RSJ International Conference on Intelligent Robots and Systems (IROS)*, pp. 4122–4128, IEEE, 2005.
- [7] L. Birglen and C. M. Gosselin, “Force analysis of connected differential mechanisms: Application to grasping,” *The International Journal of Robotics Research*, vol. 25, no. 10, pp. 1033–1046, 2006.
- [8] A. M. Dollar and R. D. Howe, “Towards grasping in unstructured environments: grasper compliance and configuration optimization,” *Advanced Robotics*, vol. 19, pp. 523–543, June 2005.
- [9] M. Liarokapis, P. Artemiadis, and K. Kyriakopoulos, “Quantifying anthropomorphism of robot hands,” in *IEEE International Conference on Robotics and Automation (ICRA)*, pp. 2041–2046, May 2013.
- [10] B. Buchholz, T. J. Armstrong, and S. A. Goldstein, “Anthropometric data for describing the kinematics of the human hand,” *Ergonomics*, vol. 35, no. 3, pp. 261–73, 1992.
- [11] M. Liarokapis, A. Zisimatos, M. Bousiou, and K. Kyriakopoulos, “Open-source, low-cost, compliant, modular, underactuated fingers: Towards affordable prostheses for partial hand amputations,” in *36th Annual International Conference of the IEEE Engineering in Medicine and Biology Society (EMBC)*, pp. 2541–2544, Aug 2014.
- [12] A. Dollar, *Design Principles for Robust Grasping in Unstructured Environments*. PhD thesis, 2006.